



Services and Analytical Catalogue

Substations Cables Transformers Overhead Lines Training



www.eatechnology.com
Australia | China | Europe | Singapore | UAE | USA

Safer, Stronger,
Smarter Networks

Who we are

EA Technology is a global, independent provider of end-to-end power engineering solutions, supporting customers in managing and operating electrical assets more efficiently, reliably and safely at lower cost.

Recognised as a world-leading expert in its field, EA Technology works collaboratively with partners across the energy, utilities, infrastructure and associated sectors to supply instruments, consultancy, services and training.

Our services

Our range of services can help provide you with a comprehensive picture of the condition of your substations, cables, transformers and overhead lines – from Forensics to Earthing, or Partial Discharge Surveys to Helicopter Inspections. Whatever your requirements we can advise on the best approach to help you manage your assets effectively, prioritise maintenance and lower your costs.



EA Technology's UltraTEV instruments won the Queen's Award for continuous innovation over 5 years.

Contents

	page
--	------

Substations	6 – 21
Cables	22 – 23
Transformers	24 – 27
Overhead Lines	28 – 35
Training	36 – 37
Forums	38 – 39

If you would like more information on any of the services you find in our catalogue please call our sales team.

Service sales:

☎ +44 (0)151 347 2367/2313

✉ sales@eatechnology.com

Contact details

Head Office & European Enquiries

EA Technology
Capenhurst Technology Park
Chester CH1 6ES
United Kingdom

t +44 (0) 151 339 4181
f +44 (0) 151 347 2404

International Offices

US Office

Bill Higinbotham
EA Technology LLC
400 Morris Avenue, Suite 240
Denville, NJ 07834

t +1 (862) 261-2759
e bill.higinbotham@eatechnologyusa.com

Middle East Office

Alan Preece, Manager
EA Technology Abu Dhabi
P.O. Box 46153
Abu Dhabi, UAE

t +971 (2) 6503629
f +971 (2) 6503629
m+971 50 2209162
e alan.preece@eatechnology.com

Australia Office

Neil Davies, Director
EA Technology Australia
7/34 Commercial Road
Newstead QLD 4006

Mail address: PO Box 2086
Fortitude Valley BC QLD 4006

t +61 (0)7 3257 3096
f +61 (0)7 3257 3098
e neil.davies@eatechnology.com.au

China Office

Dr Yuan Tian, General Manager
EA Technology China
20/F Mirae Asset Tower
166 Lujiazui Ring Road
Pudong
Shanghai 200120, China

t +86 (0)21 5174 8848
f +86 (0)21 5174 8777
e chinaoffice@eatechnology.com

Singapore Office

Victor Chan, Managing Director
EA Technology Asset Management Pte Ltd
8 Ubi Rd 2, Zervex, #03-08
Singapore 408538

t +65 6634 3591
m+65 9438 1061
f +65 6634 3590
e Victor.Chan@eatechnology.sg

The power of risk based asset management and a comprehensive health index of your HV Assets

The power of condition assessment

Our services provide you with a complete and accurate picture of the condition of your substation and cable assets, in addition to ensuring that you comply with all your obligations, including **HSG 230**. We enable you to:

- Identify faults as they develop - **before** they lead to failures
- Quantify deterioration of individual assets and groups of assets – so you can **predict** and **plan** when they require active maintenance or replacement
- Upgrade your maintenance regime from ‘time-based’ to ‘condition-based’ – which has been shown to **improve** overall asset performance at lower cost

Adopting Risk Based Asset Management

By implementing a risk based asset management system, EA Technology can help you to:

- Meet the requirements of ISO 55000 – the British Standards Institution’s specification for management of physical assets and infrastructure
- Optimise the maintenance costs for the assets - to identify the strategic importance of each individual asset and set a regime based on the condition and criticality
- Minimise the downtime and maximise availability of supply
- Optimise replacement strategy based on condition and strategic importance
- Produce regular reports on the status and condition of High Voltage (HV) Electrical Equipment and associated substation and building fabric and maintain an audit trail
- Ensure compliance with statutory requirements, regulations, standards and security
- Develop a comprehensive programme of inspections





Benefits

Assessing the condition of your assets delivers measurable return on investment. Our services will help you to:

- Achieve major reductions in costs associated with unpredicted asset failures as well as ongoing asset management
- Improve network performance, reliability and safety – in line with electricity industry best practice and regulations
- Make more intelligence-based decisions on asset maintenance and renewal

Partial Discharge Surveys

MV and HV switchgear, cables and transformers

EA Technology's ability to detect, measure and interpret data gathered on Partial Discharge (PD) activity has revolutionised the management of assets used in substations.

Our PD Surveys are carried out on live assets, without disruption and include:

service	techniques	business benefits
Level 1: Initial PD Survey	First pass survey assets, using UltraTEV instruments to check for critical PD activity levels Visual inspection	Identify assets at risk of failure Confirm assets are problem-free Report and recommendations
Level 2: Detailed PD Survey	We locate and quantify critical PD readings, using our full range of investigation instruments Expert interpretation and reports on condition data gathered	Detailed 'health of assets' report Predictions of time to failure and end of service life Quantify risk and consequences of failures
Level 3: Ongoing PD Monitoring	We measure and analyse PD activity over time, using an UltraTEV Monitor™ instrument	Accurate picture of how specific assets are deteriorating Early warning of potential failures in production-critical assets
Alarm System	Install UltraTEV Alarm™ system to provide alerts of critical PD activity in important assets	The UltraTEV Alarm™ is extremely effective for asset monitoring in post-commissioning phases
Level 4: Tailored Service	Choose regular PD inspections as part of an ongoing service contract Combine any of the above PD activity assessments with our other condition assessment techniques	Upgrade your asset management regime to fully condition-based Peace of mind assurance that the condition of your assets is fully understood

Oil Analysis

service	techniques	business benefits
Transformer Oil Analysis and PCB Detection	Oil quality Furfurals and Dissolved Gas Analysis (DGA) Full Transformer Condition Analysis (TCA) PCB Analysis	Choice of techniques to match criticality of assets Highly accurate indicator of condition, identify units at risk of failure Reports and recommendations
Live Tank Oil Sampling (LTOS™) of Ring Main Unit (RMU) switchgear	Safe, non-invasive live or offline sampling Detailed laboratory analysis and report on oil condition Cost-effective repeat testing	Identify any needs for active maintenance Safely extend maintenance schedules Savings on maintenance costs
Oil Circuit Breaker	Detailed laboratory analysis with report on findings and recommendations	Identifies appropriate maintenance interval Informs end-of-life analysis
Tap Changer	Detailed laboratory analysis with report showing findings and recommendations	Identifies appropriate maintenance interval Informs end-of-life analysis

Visual assessment

service	techniques	business benefits
Check environmental conditions, including temperature, humidity, water and dust ingress, and substation access	Qualitative assessment Quantitative assessment Action checklist	Identify environmental problems Optimise performance Increased reliability Identify simple remedial actions which may have significant impact on equipment performance

Circuit Breaker Testing

service	techniques	business benefits
Circuit Breaker Trip Test	Trip coil current profiling indicates the performance of the various elements of the tripping cycle Identify stiction, which indicates inadequate lubrication or the need for maintenance	Simple test that identifies potential performance problems Cost-effective
Secondary Injection of Overcurrent Relays	Inject overcurrent relays on or off load, to obtain overall protection performance timing	Documented test of protection performance at applied relay settings

Thermographic Survey

service	techniques	business benefits
Thermographic Survey	Infrared cameras indicate 'hot spots' which may lead to breakdown	Ensures comprehensive survey of all asset types Cost-effective

Asset Registers and Health Indices

The services we provide to gather data on asset condition also produce information which is extremely valuable for creating registers of assets. We can help develop these essential management tools in two ways:

service	techniques	business benefits
Level 1: Basic Register of Assets	Prepare a full register of assets, with equipment specifications and serial numbers Implement procedures for regular updating Audit every 5 years	Improved visibility of your asset portfolio Essential foundation of effective asset management Compliance with HSG230
Level 2: Health Index of Assets	Apply condition assessment data to your assets Use our unique 'health index' methodology to prioritise maintenance and replacement	Upgrade your asset management regime from 'time-based' to 'condition-based' Make accurate end-of-life predictions Take smarter, intelligence-based decisions on revenue and capital expenditure
Level 3: Condition Based Risk Management (CBRM™)	Upgrade your asset management regime to our full CBRM™ methodology	Factor in risks of asset failure as well as asset condition The most effective and comprehensive asset management system available

DIN/SOP/NEDER Safety Compliance

We can keep you fully updated on any current and future DIN/SOP/NEDER directives affecting existing plant or planned modifications.

service	techniques	business benefits
Advice on all directives	Review of regulations which affect you Ongoing updates as new regulations are issued Expert advice from a single source	Save management time Cost-effective service Ensure compliance

Partial Discharge (PD) Surveys for High Voltage Substations

Expert independent condition assessment of your power assets including continuous monitoring

Measuring partial discharge (PD) activity in your High Voltage/Medium Voltage (HV/MV) assets gives you a clear picture of the true condition of your power assets, so you can schedule your maintenance programme based on actual condition rather than time intervals, saving you both time and money. EA Technology can conduct a full PD Survey of all your power assets for you, giving you the benefit of a concise report, accurate results and expert analysis.

Benefits

- Improve operator safety and network reliability
- Early identification of any deterioration will eliminate unexpected disruption and failure and provide accurate condition assessment
- Eliminate the need to invest capital in survey instruments and staff training
- Non-intrusive – no shutdown required for survey
- Provides compliance with the recommendations of HSG 230 (Health and Safety Executive guidelines, keeping Electrical Switchgear Safe)

Features

- Survey conducted using our advanced PD location and measuring equipment
- Your results compared on an asset-specific basis with our unique database of over 20,000 test records
- Concise report provided with clear recommendations
- Instruments measure Transient Earth Voltages (TEVs) and Ultrasonic activity
- Reassurance of a totally independent survey and report provided by expert engineers with over 40 years' experience in interpreting PD data



What is PD?

A partial discharge is an electrical discharge or spark that bridges a small portion of the insulation between two conducting electrodes in HV assets. Over time this can degrade the insulation leading to failure. For further details on Partial Discharge watch our short videos at:

www.eatechnology.com/about-partial-discharge

Why measure PD activity?

Once present, PD activity always increases and, if left undetected, will deteriorate towards a failure which can be sudden and catastrophic. Our survey conclusions are totally independent as we do not manufacture, refurbish or maintain HV/MV assets. PD activity is the most reliable indicator of the true condition of insulation within live assets.

fact: 85% of disruptive substation failures are PD related.

How will a PD Survey help you manage your assets?

EA Technology's experienced service team can be deployed worldwide with the latest technology to test for and identify PD activity in all substations. Combining their knowledge with our world leading range of instruments to detect, locate and measure PD activity, our expert engineers will conduct a thorough survey of all your live substation assets. In the case where HV assets are in areas of high electrical noise or there is a suspected intermittent fault, we can install continuous monitoring equipment for a period to measure activity.

We then conduct detailed analysis based on our experience of over 40 years of interpreting PD data to provide the most accurate prediction possible of future deterioration and failure. You will receive an easy-to-understand 'traffic light' status report with clear and totally independent recommendations for managing your power assets based on their true condition.



Testing your Protection Systems

Combining protection secondary injection and trip mechanism timing tests

Testing over-current protection relays and circuit breaker trip mechanisms has been recognised as a key part of any HV/MV switchgear maintenance regime.

The best way to evaluate both your protection relays and circuit breaker trip mechanisms is to simulate the precise conditions that will occur during a fault and record the circuit breaker performance.

Based on advances in testing technology, we are now able to combine both of these tests. All parts of your protection system are evaluated at the same time, saving you outage time and reducing network disruption.

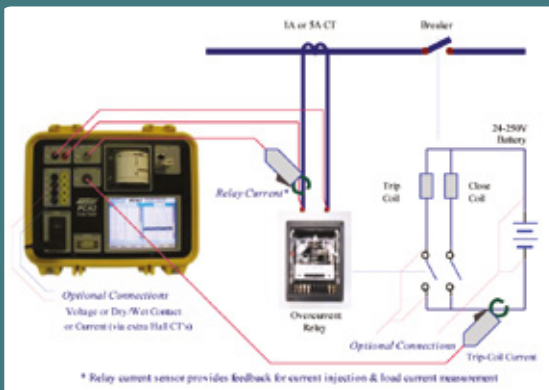



Benefits

- Combined tests will reduce the outage time and network disruption
- Comprehensive simulation tests allow your protection system performance to be assessed against realistic fault conditions
- Extensive test data on the circuit breaker gives you accurate information on the performance of your protection system based on the actual condition of assets
- Vital information is gathered on the condition of the circuit breaker trip coil and mechanism without the need for invasive maintenance

Features

- Combined test of over-current relay and trip mechanism
- Testing carried out 'on-load'
- Captures vital 'first-trip' operation data
- Checks over-current relay sensitivity
- Records current profile of trip coil
- Provides an assessment of the tripping supplies

This non-invasive condition-based testing system will allow you to analyse the condition of your protection system while minimising downtime and disruption. The combined tests simulate realistic fault conditions to provide you with accurate results on the condition and performance of both your protection secondary injection and trip mechanism systems while the network is 'on-load'. With a built-in printer to provide you with an instant hard copy printout, you have the information you need to schedule your maintenance activity as effectively as possible.

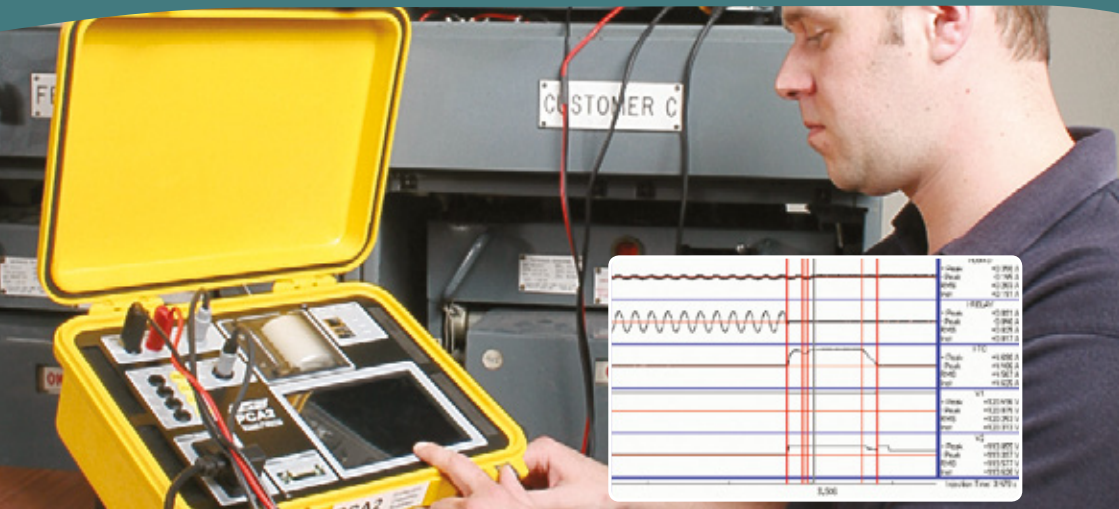

Live Tank Oil Sampling (LTOS) and Analysis

Condition assessment and optimisation of maintenance intervals for oil-filled switchgear.

Benefits

- Saves money by eliminating wasteful, time-based maintenance
- Oil condition accurately indicates whether invasive maintenance is required or not
- Safely extends periods between maintenance interventions
- Identifies degradation of specific components before they lead to failure
- Warns of switchgear degradation problems before they lead to failures
- Increases asset reliability and reduces costs
- Cost-effective and safe proven method of retrieving an oil sample, causing minimal disruption to the network

Facts

- Over-maintaining oil-filled switchgear wastes money, disrupts production and reduces network reliability
- Optimising maintenance with LTOS cuts costs, minimises disruption and improves reliability



LTOS service

Oil Sampling

- A 50ml sample is taken through a cover plate, tailored to the specific switchgear type and placed over the open, earthed test access of the live asset
- The syringe is sealed, labelled and returned to EA Technology for analysis
- The process is well-proven, safe and causes minimal disruption to the network

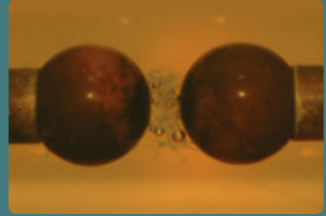

Oil Analysis and Reports

- Laboratory analysis of the degradation curve shows how long oil can be left safely in the equipment before maintenance is required
- The analysis picks up characteristics in the oil which indicate that specific components are on the path to failure
- Clients receive a report on the condition of the asset, together with maintenance recommendations



Example: 80% Cost Saving

Moving to LTOS from time-based maintenance has reduced the cost of maintaining 500 units by more than 80% per annum for one of our clients. The safety and reliability of their network has also improved, thanks to lower switching requirements and rates of failure.



Power Forensics™

Understanding the condition of power assets

Failure investigation and prevention

Establishing the causes of power asset failures to prevent future failures.

The world's leading experts for:

- Investigation
- Causes
- Evidence
- Prevention

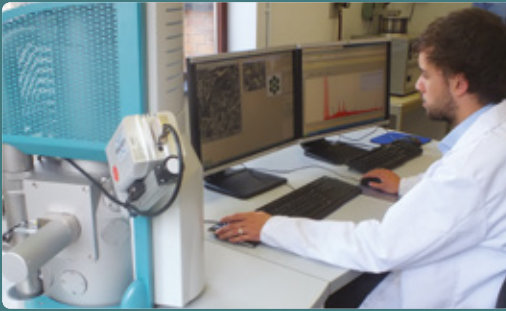

Comprehensive experience

EA Technology has been supplying forensic investigation, failure analysis and accident investigation services for more than 40 years.

We cover every industry, in any country, from EHV transmission and distribution, to low voltage controls and components.



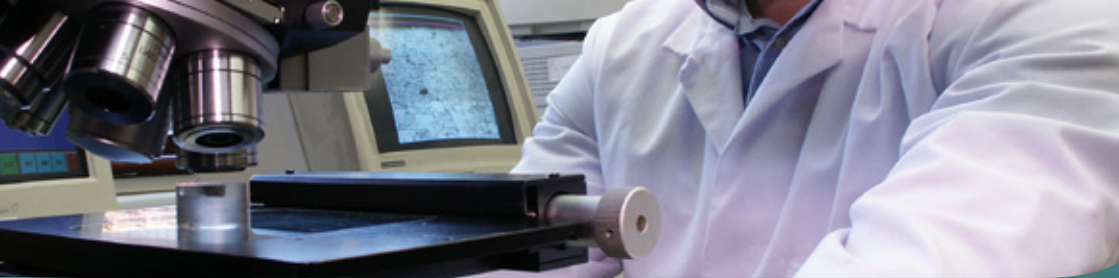

International services

Experienced investigators with multi-disciplinary expertise

- On-site incident examination and assessment
- Proven investigation procedures
- Modern analytical techniques
- Expert eye witnesses
- Fast, confidential service

Benefits to your business

- Prevent future failures, interruption in supply and loss of production
- Gather expert evidence for issues of legal responsibility, litigation and claims
- Improve safety, operating procedures, maintenance practices, reliability and design
- Support asset management decisions in areas including:
 - Reliability predictions
 - Risk analysis
 - Maintenance policies
 - Replacement and investment decisions

Identifying causes of failure

- Operator error
- Lack of maintenance
- Poor installation
- Manufacturing defects
- Deliberate damage or sabotage
- Environmental factors
- Service or operational issues

Analytical facilities

- Highly skilled and experienced personnel
- Scanning electron microscopy, optical microscopy, mechanical testing and materials analysis
- High voltage experimental and test facilities
- Oil condition analysis
- Bespoke experimental projects



Earth System Whole Site Audit

EA Technology's Earthing System Site Audit service is the equivalent of an MoT inspection, to ensure that protection systems on private network operators' high voltage installations will operate appropriately during a fault. This is essential to comply with current safety regulations, including BS 7430, and to prevent damage to plant and personnel.

Business benefits

- Whole site survey checks the integrity of all earthing systems
- Identify installations where remedial action is required
- Comply with safety regulations
- Prevent damage to network assets and personnel
- Reduce risk of liability and claims
- Fast and excellent value
- Bespoke design service for earthing system upgrades
- Ensure that protection systems will operate safely in the event of a fault

Typical applications

- Ensuring sites' compliance with BS 7430
- Updating maintenance and safety procedures
- New operating conditions





Earthing Protection Site Audit Process

1 site survey and measurement

Earthing System Audits begin with a visual inspection of all electrical bonds to equipment. We then measure:

- Soil resistivity to assess the impedance of the soil surrounding the electrodes
- Resistance to check the integrity of the earthing system
- Continuity to ensure that all equipment is bonded together and to earth

2 computer modelling and design

Survey data is fed into the latest CDEGS 3D computer model to produce:

- A simulation of the existing earthing system's performance under fault conditions
- The effects of changes in the system on performance

3 reports and recommendations

Outputs from the site audit include:

- Recommendations for changes to the system, if required, with follow up measurements to check their effectiveness
- Updated earthing policy documents
- Review of maintenance procedures and practices
- On-site training courses



Lightning System Audit

EA Technology's Lightning System Audit service provides independent, expert advice on the most cost-effective lightning protection systems to guard against damage to assets from electrical storms, and because we do not sell or install one-size-fits-all protection systems, they ensure the optimum balance between cost and risk mitigation for specific sites.

Our recommendations ensure compliance with the British Standard Agency's BSEN 62305 guidelines, which became a regulatory requirement in 2008.

Business benefits

- Recommendations are based on detailed site surveys by EA Technology experts
- Independent advice can be used as the basis for internal work plans or external tenders
- Our lightning protection systems are purpose-designed for your needs, to maximise value
- Minimise risk to your assets and personnel
- Ensure compliance with BS EN 62305

Improving asset performance

- Protection
- Compliance
- Value
- Safety

3 steps to cost-effective Lightning Protection

Our protection systems are more cost-effective than generic solutions, because they are based on the specific risks to each structure

1 Site survey and measurements

- We survey the location and purpose of structures to be protected in your site
- We carry out a detailed survey of existing lightning protection systems on-site, including:
 - Assessing their effectiveness
 - Identifying current systems which are suitable for modification
- We perform measurements to establish the suitability of using existing structures as part of the lightning protection system

2 Risk assessment

The first step is to establish how much the structures on your site are at risk of lightning strikes. We therefore:

- Check detailed records of lightning activity in the area of the site over the past 20+ years, collected by our unique Lightning Location Data and Display System
- Examine the geographical location of your site. This process provides a precise, individual and usable lightning risk assessment

3 Recommendations

We combine the information gathered in Stage 1 and 2 to provide a detailed risk assessment of individual structures, based on historical strike data for the area, vulnerability and existing protection systems.

- We identify areas of the site where lightning protection is required
- We provide recommendations on the most appropriate techniques for lightning protection, based on our analysis of risk and cost/benefits

Our records of lightning activity in the British Isles go back to 1989



SF₆ Onsite Testing and Sampling Services

SF₆ is becoming more commonly used as an insulation medium in electrical power equipment, due to its unique physical properties. Since SF₆ is a strong greenhouse gas, EA Technology pays special attention to the environmental aspects of the SF₆ technology. In particular, the systematic SF₆ handling strategy of EA Technology guarantees an environmentally safe and sound use of SF₆.

EA Technology can provide gas quality testing, degassing and top-up of SF₆ filled HV equipment including:

- Calibrated pressure tests
- SF₆ Gas purity
- SF₆ Gas dew point
- SF₆ Acidity
- SF₆ Decomposition products
- BGA

All work is carried out by trained and authorised personnel in line with current European regulations.

Why test SF₆ gas?

- Improve safety
- Minimise environmental impact
- Save maintenance costs
- Improved handling practices
- Early detection of gas breakdown
- Breaker gas analysis





Advantages

- Maintenance costs are reduced by identifying breakers in need of maintenance
- Internal components are monitored reducing the need for internal inspections
- Gas processing and handling costs are reduced
- Reliability is improved
- Safety is enhanced
- Trending of gas quality over time

We have developed a team of well-equipped SF₆ specialists who regularly carry out transfer and replacement operations with this insulating medium. All work is meticulously planned for safety and is fully compliant with SF₆ gas and other environmental regulations.

SF₆ training courses

EA Technology provides certified training for personnel who need to recover and top up SF₆ insulated switchgear. The course leads to the issue of a competency certificate and card in accordance with current greenhouse gas regulations.



Cable Partial Discharge Mapping Service™

Non-destructive Partial Discharge (PD) site testing of HV/MV cables measures and reports on the health of all cables up to 66kV.

Business benefits

- Fast and accurate site service
- Works with paper and polymer insulated cables
- Reduces the need for expensive excavation work
- Ideal for pre-commissioning and post-repair tests
- Locates partial discharge activity in cables before it leads to failures
- Reduces the risk of unplanned, expensive outages

Non-destructive VLF testing

The Cable Partial Discharge Mapping Service™ works on the principle of energising HV/MV cables at Very Low Frequency (VLF), making the system very portable and requiring only a 13amp 230V supply.

Time-of-flight measurements are used to calculate cable length, then all captured data is processed using EA Technology's bespoke software. The software calculates the location and magnitude of recorded PD waveforms.

Our system is safe, non-destructive and has a 15 year track record of success, from the UK to the Far East.

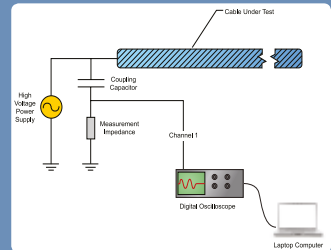



Multiple applications

The service is effective on all types of HV/MV cable up to 66kV. Paper insulated cables can be tested to approximately 5km in length and polymeric insulated cables up to approximately 8km in length.

Typical uses include:

Pre-commissioning	Checks the condition of cables and joints before they are put into service
Post-repair	Safely tests the integrity of cables that have been repaired without the risk of overloading the cable, which is inherent in 'withstand' tests
Fault detection and diagnosis	Identifies partial discharge in cables and joints at an early stage of their development, before they lead to disruptive failures
Condition data gathering	Collects information on the condition of cable assets, including confirmation that cables are free of partial discharge
Risk analysis	Enables the production of a Health Index for each cable asset, so that the probability and consequences of failure may be calculated
Investment prioritisation	Empowers asset managers to make intelligence-based decisions on cable maintenance and replacement strategies

Valuable condition data

Cables and joints which exhibit deterioration in the form of PD activity are identified by the system as pulses of electrical energy and measured in pico-Coulombs (pC). The magnitude of discharges in each phase is displayed as a function of distance along the cable.

Information from all the PD events can be combined to produce a 'discharge map': a comprehensive picture of the condition of the whole cable and its joints. This enables us to provide detailed reports on where partial discharge is present and the likelihood of it developing into a failure.

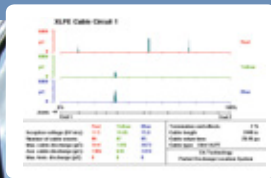

Assessing the internal condition of oil-filled transformers

To improve reliability and assist in determining appropriate asset management decisions.

Benefits

- Tests provide an accurate assessment of internal condition of the transformer
- The condition data in conjunction with other information such as operational duty, transformer history, environment etc. is used to derive a Health Index
- Probability of failure and end-of-life are calculated
- Identifies degradation of specific components before they lead to failure
- Enables operators to develop effective maintenance and replacement strategies based on the condition of the transformer
- Identifies transformers that could benefit from life extension measures
- Low cost test process
- Excellent return on investment

Fact

Creating Health Indices is an essential part of the move towards Condition Based Risk Management™ (CBRM)



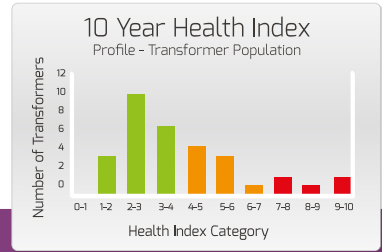
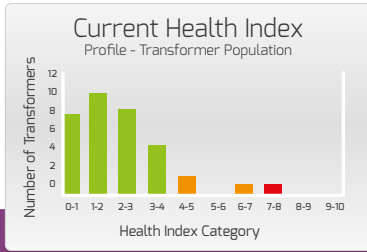

Oil-Filled Transformer Testing and Analysis

EA Technology's extensive experience shows that oil analysis is the most cost-effective way to assess the internal condition of oil-filled transformers. Some of the tests we carry out are as follows:

■ Oil Quality

Measuring moisture, acidity, solid contamination and breakdown strength of the oil gives a good indication of the overall condition of the oil and internal components. The quality of the oil is also critical in preventing premature ageing of the transformer and extending service life.

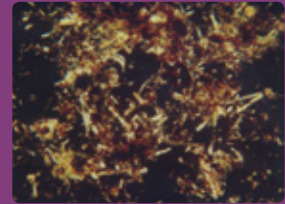

Severely degraded paper insulation, DP200 indicating high probability of transformer failure

■ Furfuraldehyde Analysis

Furfuraldehyde analysis gives an accurate indication of the condition of paper insulation. The furfuraldehyde content is correlated to the degree of polymerisation of the paper. When furfuraldehyde levels reach specific values, we know that the insulation has effectively broken down and the probability of failure is very high.

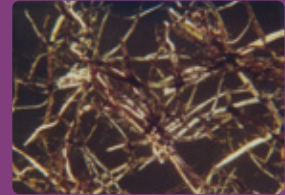

New paper DP1000

■ Dissolved Gas Analysis (DGA)

Analysing the levels and ratios of different dissolved gases in the oil identifies electrical discharge, arcing and thermal activity within the transformer.

Oil-filled transformer health indices

The oil analysis provides a very good understanding of the internal condition of a transformer, including the condition of specific components.

The oil analysis results are used in combination with relevant background information to create a Health Index for the asset, expressed as a numerical value on a scale of 1 – 10 from which a Probability of Failure (PoF) and estimated end-of-life are determined. In addition the application of an ageing algorithm enables the future performance and condition to be evaluated. This is particularly valuable for prioritising the maintenance and replacement of multiple assets and is the foundation of Condition Based Risk Management (CBRM).

Transformer Diagnostic Testing

Power transformers are among the most strategically important and expensive components on any network, and data on their health is therefore vital for effective asset management.

Business benefits

- Develop Health Indices to estimate end-of-life
- Check condition following fault conditions or overloading
- Extend transformer life
- Maintain high utilisation of existing transformers
- Improve loading capabilities
- Identify transformers at risk of failure
- Prevent expensive and disruptive failures
- Minimise replacement costs
- Improve decision making for future load requirements
- Improve safety

Market-leading service partners

- EA Technology has 40+ years' experience of working with electricity asset operators
- We provide comprehensive on-site testing and analytical services
- Plus in-depth expertise and support for clients to optimise their asset management
- Testing programmes tailored for individual clients





Transformer testing services (UK only)

- Winding resistance
- Excitation current
- Turns ratio
- Capacitance
- Tan Delta
- Sweep Frequency Response Analysis (SFRA)
- Dielectric response
- Leakage reactant
- Partial Discharge

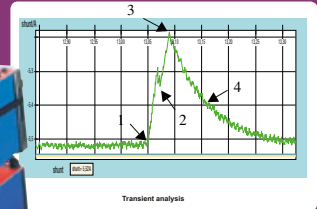

Omicron test equipment

Added value management information

Transformer Diagnostics Testing is a key element in effective, condition based asset management, which can:

- Establish the present condition of transformers
- Determine their future performance
- Identify if current maintenance practices are suitable – or further interventions are required
- Help evaluate financial and operational risks to the business



Helicopter Inspection Service

Electricity Tower Condition Assessment

A complete airborne service for the inspection and management of power lines, providing a comprehensive breakdown of the condition of each tower.

Benefits

- Provides tailored information to feed into EA Technology's Condition Based Risk Management (CBRM) process
- Inspects your network in a quicker, more comprehensive and cost-effective way than conventional foot and climbing inspections
- Uses a standardised and consistent method for objective condition assessment
- Produces a permanent photographic record for regulatory, legal and auditing purposes
- Delivers a written summary report which facilitates objective prioritisation of maintenance and remedial work using Health Indices
- Enhances strategic planning and investment decision making using Condition Based Risk Management (CBRM)



Condition Based Risk Assessment of Electricity Towers

Inspection process overview

Each airborne assessment is specifically tailored to your requirements, your industry and the relevant regulations with which you have to comply. The following flowchart details the step-by-step process:

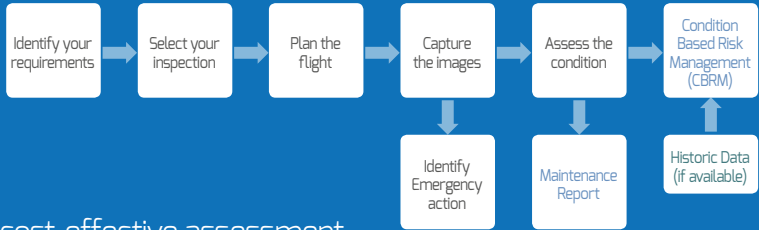

A complete cost-effective assessment

An airborne Electricity Tower Condition Assessment from EA Technology is an efficient and effective way to meet both your regulatory obligations and your strategic asset management objectives.

Each assessment captures a large number of highly-detailed GPS-tagged digital images of each tower, which allow us to provide a detailed condition assessment of the tower structure and fittings.

From this we can determine Health Indices for prioritising maintenance and remedial work, which can also be used in our unique Condition Based Risk Management (CBRM) process, to help with strategic network decision making and investment planning.

The inspection results format can be tailored to suit the requirements of your business model and the specific demands of your utility, with all results electronically cross-referenced for a range of uses and legal records. You'll even be able to 'fly' the network yourself from your desk to see the results.

Maximum information from a single visit

An airborne Electricity Tower Condition Assessment is a consistent and reliable means of obtaining and capturing all the information you need in one visit, avoiding the need for costly separate visits such as:

- Safety and security foot inspection (e.g. signage and anti-climb guards)
- Routine climbing inspection
- Detailed refurbishment climbing inspection
- Thermal inspection (can be performed at the same time)

What's more, an airborne inspection avoids the need for network isolation and HV switching.



Tower Foundation Condition Assessment Service

Maintaining the integrity of a steel lattice overhead line is vital to ensure reliability of the electricity transmission network and a key component of the steel tower overhead line network is the foundation. Traditionally, foundations can be excavated to allow inspections to take place, however these are disruptive, time consuming and expensive.

The value of non-intrusive techniques is to provide general information on the state of foundations and identify individual towers within a group which are most likely to have suffered significant corrosion or foundation damage.

Business benefits

- Cost-effectively prioritise the tower foundations
- Significantly reduce the number of excavation inspections
- Identifying the towers at most risk of significant corrosion damage in the future
- Concentrated limited resources on the most relevant towers
- Increased confidence of the overall condition of the tower foundations for a given route





Assessment methods

EA Technology has developed a selection of assessment methods that allow a certain degree of flexibility, which is essential due to the significant variation in foundation types across a typical operator's network. Different inspection methods can be selected depending upon the outcomes required. The individual inspection methods are as follows:

- Visual inspections
- Corrosion current and voltage potential
- Transient dynamic response and time echo response
- Soil resistivity
- Soil chemistry
- Redox potential

Summary

The results of the measurements can be combined and used to estimate the likelihood and rate of future corrosion, and therefore present recommendations regarding the need for excavations or refurbishment. EA Technology has developed a method for combining the individual measurement results, applying weightings depending upon the overall effect on future corrosion, and calculating the likelihood of future corrosion as a result.

Condition ratings can then be applied to each tower leg in order to prioritise for excavation or remedial work, should it be required.



Helicopter Inspection Service

Electricity safety, quality and continuity inspection

An airborne inspection service developed specifically to assist network operators to meet the requirements of the Electricity Safety, Quality and Continuity Regulations (ESQCR) easily, accurately and cost-effectively.

Benefits

- The most cost-effective way to comply with ESQC regulations
- Faster and more efficient than foot patrols
- More comprehensive, more accurate and more consistent information
- Avoids the safety and land access issues of foot patrols
- Includes GPS technology for accurate tower identification
- Results assessed by experienced staff and provided on simple spreadsheets
- Permanent photographic records provide compliance with legal and regulatory obligations
- Provides reliable information to help justify and prioritise remedial work



ESQC Regulations

The Electricity Safety, Quality and Continuity Regulations 2002/6 are designed to ensure the quality and continuity of supply to customers, while minimising any risk that the distribution network may present to members of the public.

These regulations require that any network operator shall, so far as is reasonably practicable, inspect their network with sufficient frequency that they are aware of any action that may be needed to ensure compliance with the regulations. In the case of overhead lines, network operators are also required to maintain a record of these inspections for at least ten years, together with a record of any recommendations arising from the inspection.

EA Technology Helicopter Inspection

EA Technology's airborne ESQC/Safety Inspection Service is the fastest, most accurate and most economical way of meeting the requirements of these regulations. Focusing purely on the safety, regulatory and risk-from-third-party aspects of tower inspection, the ESQC/Safety Inspection allows network operators to check the safety and security of all the overhead electricity distribution lines on their network, quickly and easily, without incurring the higher costs of a more detailed inspection.

Efficient and cost-effective

EA Technology's Helicopter Inspection Service has been designed to overcome all of the limitations of foot patrols, making it easy to ensure your network complies fully with the ESQC regulations.

Our airborne inspections combine the skills of a trained visual observer with those of a cameraman recording high-resolution photographs, to give you a detailed, expert and verifiable assessment of each tower.

The observer captures information that is best determined using the naked eye - such as land use, land type, risk of third party interference and conductor tree encroachment - recording this data consistently and accurately using a special touch screen interface designed by EA Technology for use in the helicopter.

At the same time, the cameraman captures a small number of high-resolution images of the whole tower, as well as images of critical parts around the base, such as the warning signs and anti-climbing devices. These contain a far greater level of detail than it is possible to see using the naked eye from the helicopter.

Output

The visual and photographic elements recorded for each route are then merged and presented in a custom designed spreadsheet.

Each feature is graded and colour coded to illustrate its status, with hyper-links providing immediate access to the associated images directly from the spreadsheet.

Whilst the information captured may vary slightly from one client to another, it will typically include an assessment of the following:

- Land type and use
- Risk of third party interference
- Major defects
- Tree encroachment within span
- Vegetation growth around tower footings
- Condition of safety and warning signs and anti-climbing devices
- Evidence of vandalism or illegal attachments

All spreadsheets and images are provided on a portable USB memory stick, allowing the results to be viewed on virtually any PC or laptop.

Lightning Location Data and Display System

EA Technology's Lightning Location System has the unique ability to plot and display lightning strikes in real time and provide historical data on lightning activity across the UK and Ireland over the past 20+ years.

Our system is the only system that concentrates on recording just cloud-to-ground strikes. Hence we only monitor the strikes that can actually cause damage or danger to personnel. This means that if you are trying to identify a strike that has damaged some equipment, the data is not disguised within a large number of cloud-to-cloud, intra-cloud or cloud-to-air strikes which cannot have caused the damage.

Subscribers to this extraordinarily valuable service include members of the electricity, telecoms and insurance industries.

Business benefits

- Subscribers receive online lightning information, within seconds of each strike
- Lightning protection equipment can be checked on overhead lines following severe lightning activity observed in their area
- Increased safety for staff working in high risk locations, including tall structures
- Enables managers to deploy repair crews to vulnerable areas in advance, so minimising disruption
- Historical data provides evidence for (or against) lightning as the cause of damage in insurance claims

Features

- PC-based online user interface
- Six detection outstations monitor the whole of the UK and Ireland
- Each outstation can detect up to 100 strikes per second
- Proven system, in operation since 1989





User friendly

- Easy to set up subscription service provides full access to online lightning data
- PC software included
- User friendly graphical interface
- Historical data displays in Google Maps

Accurate real time data

- Strike locations are calculated to 100m accuracy and referenced to Ordnance Survey grid
- Time-of-strike measured to within one millisecond
- Evidence of strikes appears on subscribers' screens in seconds (often before they hear the thunder!)

Valuable management information

- Enables managers to plan for approaching electrical storms
- 'Replay' data on lightning activity is available to determine the causes of damage
- Our 20+ years record of activity identifies lightning hot spots - essential for evaluating risk to key assets

The system enables subscribers to see how electrical storms develop and move, as well as providing access to accurate records of past lightning strikes.

Lightning plots are colour coded by time-of-strike, so it is easy to see how activity is developing

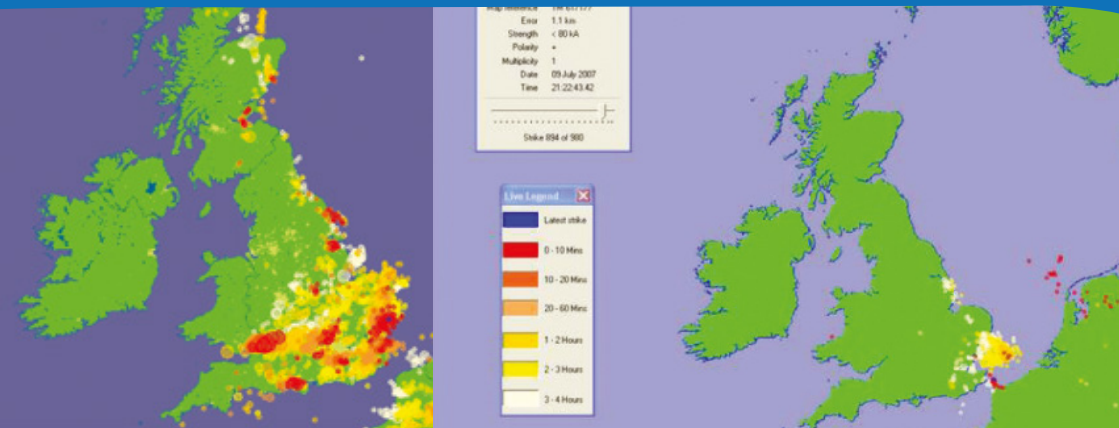

With an unparalleled technical heritage, EA Technology's Power Skills Centre is uniquely positioned to provide training to meet the needs of the power industry.

EA Technology has been at the forefront of driving innovation within the industry and improving network performance for nearly five decades. This practical experience and knowledge underpins our training provision and ensures the optimum balance between theoretical understanding and practical application.

We offer one of the most extensive ranges of specialist, power engineering courses available to professionals working within the industry. We can also provide tailored training courses and modular workforce development programmes. These expert-led programmes offer structured development routes for a range of power engineering roles and can be customised to meet the specific training requirements of particular groups and competence levels.

Our training provision has been externally assured as complying with the highest standards in the field. We are a National Skills Academy for Power assured Education and Skills Provider and an Institute of Asset Management approved training supplier. We are an accredited member of the Continuing Professional Development Certification Service ensuring our courses can count towards CPD requirements.

Core module index

- 1 Power Industry Foundation
- 2 Substations, Switchgear and Transformers
- 3 Overhead Lines
- 4 Cables Technology
- 5 Network Planning and Design
- 6 Power System Protection
- 7 Earthing
- 8 Distributed Generation
- 9 Project Management

Course listing

Course index by category

Substations Courses

Gas insulated switchgear and GIS substation essentials

Insulating oil handling and analysis course

Partial discharge (PD) training

SF₆ training and certification

Substation design - a practical guide

Substation earthing course

Switchgear technology for power systems

Transformers for power systems

Cables Technology Courses

Cable joints, terminations and accessories

Cables for power systems (Part 1)

Cables for power systems (Part 2)

Oil-filled cable systems

Power cable fault location

Power Networks Courses

Application of variable speed drives and rotating machines

Distributed generation

Distribution overhead lines

Distribution planning (Part 1)

Distribution planning (Part 2)

Network planning foundation course

Stability and voltage control in electrical power networks

Wind farms - a project manager's guide to the electrical aspects

Protection Courses

Commissioning and testing

Power system protection (Part 1)

Power system protection (Part 2)

Specialist Courses

Engineering recommendation G5/4 and power quality workshop

The essentials of Asset Management

PAS 55 to ISO 55000: Are you ready?

Power systems for private network operators

Electrical safety conference - safe working practices

Failure analysis and investigation

Impacts of low carbon technologies on networks

Introduction to smart grids

Lightning protection - for MOD sites with explosives facilities

ISO 55000: The route to effective Asset Management

Power systems engineering

Project management - managing electrical projects

Regulation: what it means for a distribution network operator

Understanding lightning protection

Industrial Forum for Electrical Engineers

The Industrial Forum for Electrical Engineers was initiated in 2004 by EA Technology, and continues to be hosted at EA Technology's offices in Capenhurst, Cheshire. The forum was designed to actively encourage open debate and shape 'best practice' between UK based electrical engineers from a wide range of industries within the private sector.

The Forum provides an open and friendly environment in which members are encouraged to contribute to discussions on current practices and asset management issues, and continues to be an effective and important platform for cross fertilisation of ideas between engineers from a variety of sectors.

Benefits of membership

- Network with senior engineers from a wide range of industries in a friendly, open environment
- Gain industry insight first hand from a range of guest speakers
- Benefit from useful updates on policies, procedures and changing standards
- Discuss new products and services as well as up and coming developments and issues
- Share ideas, constraints and problems – discuss solutions
- Interact with members all year round on the group's dedicated LinkedIn Forum



Wind Power Forum for Engineers

The Wind Power Forum is uniquely only for engineers operating or managing wind power. It's the place to meet your peers, the people who have the practical experience and responsibility to operate wind power and EA Technology – the people who empower the industry.

The informal structure of the forum provides the ideal opportunity to discuss your challenges, your successes, and what could be done to improve operations and planning in the future.

Who should join?

The Wind Power Forum is a specialised event - only for asset managers, engineers and others responsible for operating, maintaining or managing wind farms both on and off-shore.

Benefits of membership

- Network with other senior engineers from on and off-shore wind farms in a friendly, open environment at our biannual member event
- Sector specific insight and case studies delivered by those working within wind power
- Gain industry insight first hand from a range of guest speakers from organisations that support and service the High Voltage (HV) electricity sector
- Acquire useful insight on new policies and procedures, new products and services as well as an opportunity to discuss up and coming developments and issues
- Share ideas, constraints and problems – discuss solutions
- Interact with members all year round on the groups dedicated LinkedIn Forum



Global footprint

We provide products, services and support for customers in 90 countries, through our offices in Australia, China, Europe, Singapore, UAE and USA, together with more than 40 distribution partners.



Our expertise

We provide world-leading asset management solutions for power plant and networks. Our customers include electricity generation, transmission and distribution companies, together with major power plant operators in the private and public sectors.

Our products, services, management systems and knowledge enable customers to:

- Prevent outages
- Assess the condition of assets
- Understand why assets fail
- Optimise network operations
- Make smarter investment decisions
- Build smarter grids
- Achieve the latest standards
- Develop their power skills

Safer, Stronger,
Smarter Networks

www.eatechnology.com

Australia	China	Europe	Singapore	UAE
+61 (0) 7 3257 3096	+86 (0) 21 5174 8848	+44 (0) 151 339 4181	+65 6634 3591	+971 (2) 650 3629